

31-18-02

1.

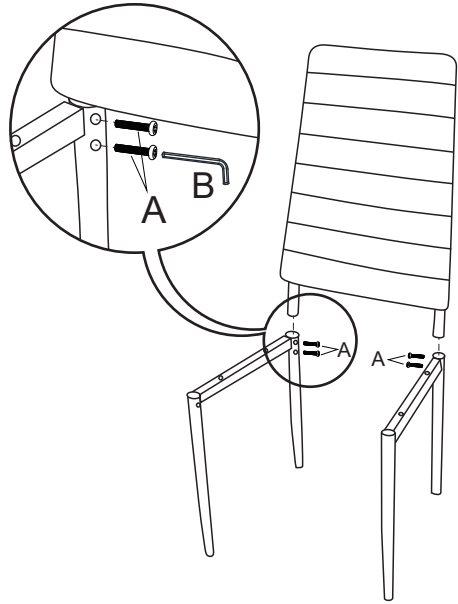

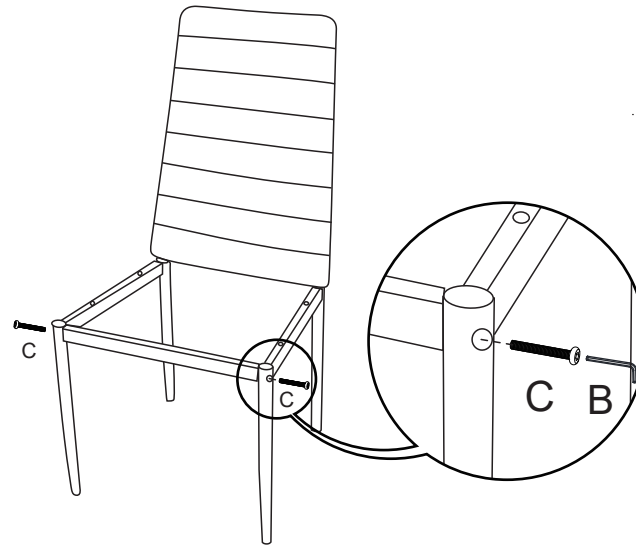



2.

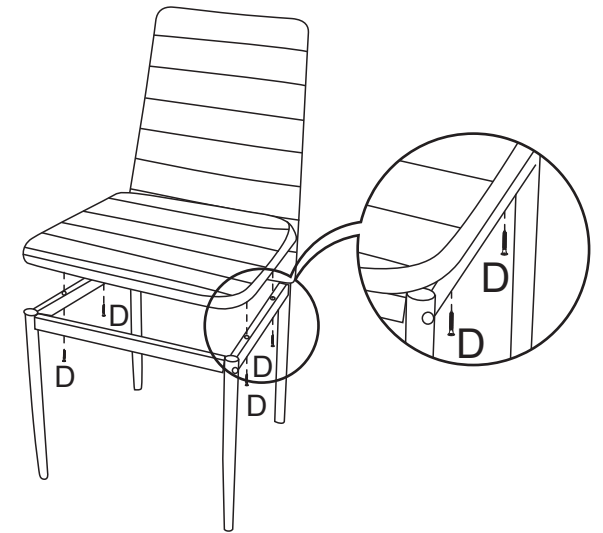

3.



# Assembly Instructions

A	 x4	B	 x1	C	 x2	D	 x4
---	--	---	--	---	--	---	--